

**Garage Doors** MADE BY RYTERNA





# Content

TL&R40   RIB	10
TL&R40   MIDRIB	12
TL&R40   FLUSH	14
TL&R40   CASSETTE	16
TL&R40   SLICK	18
TL&R40   SLICK PLUS	20
TL&R40   MICRORIB	22
TL&R40   MACRORIB	24
TL&R40   TOPRIB	26
TL&R40   RETRO	28
SIDE HINGED GARAGE DOORS	31
SIDE DOORS	32
PASS DOORS	33

DECOR APPLIQUES	35
STAINLESS STEEL WINDOWS	36
ACRYLIC DOUBLE GLAZED WINDOWS	36
FULL VISION PANELS	37
HARDWARE TYPE R40	38
HARDWARE TYPE TL	42
ACCESSORIES	46
THE SIDE SLIDING SECTIONAL DOOR	48
HARDWARETYPE	50



# Unlimited creativity

Freedom to express your ideas in many ways.





# Think outside the box

A diversity of modern designs, variety of colours, number of features. Whether to merge with the general architecture, or to create a statement in your neighbourhood. Long-lasting solutions and no halfway measures with the quality.







## Look and functionality

Straight lines and square shapes for a minimalistic, contemporary view or just a simple solution to cover your garage space from the outside.





TL&R40 | Rib

## TL&R40 | RIB

Horizontal ribs every 10 cm give this door a light yet sturdy appearance.

This is a door with a contemporary appearance that looks good in any architectural setting.

Wood Rib comes in 4 different natural looking wood finishes - Golden Oak, Old Oak, Dark Oak and Mahogany.

Rib doors are often combined with full-vision aluminium panels available in any RAL colour and also a golden oak finish.

Rib type doors are best in special oversized openings – they can be made up to 10 metres wide.



Around 200 RAL colours available.

### Panel styles:



RAL 9016  
(woodgrain)



RAL 9016  
(stucco)

### Wood images:



Golden Oak  
(woodgrain)



Old Oak  
(woodgrain)



Dark Oak  
(woodgrain)



Mahogany  
(woodgrain)

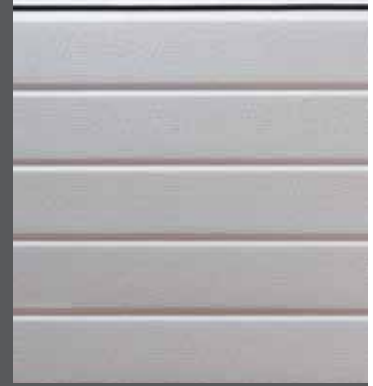



TL&R40 | Midrib

## TL&R40 | MIDRIB

The Midrib style door, grooved in the middle of each panel, gives the impression of solid timber boards. This is a popular style all over Europe. Midrib panels are available in woodgrain, stucco and smooth patterns, in standard white RAL 9016 or any other RAL colour. The Wood Midrib style door comes with a smooth, non-embossed surface, coated with a natural wood looking UV proof PVC covering. Mahogany, Golden oak, old oak and light oak finishes are available.

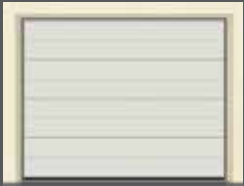

Around 200 RAL colours are available.

### Panel styles:



RAL 9016  
(woodgrain)



RAL 9016  
(stucco)



RAL 9016  
(smooth)

### Wood images:



Golden Oak  
(smooth)



Old Oak  
(smooth)



Light Oak  
(smooth)







TL&R40 | Flush

## TL&R40 | FLUSH

The Flush door design with its smooth panels, woodgrain or stucco embossed surfaces offers a look that complements both period and modern homes. The look is subtle and understated but is impressive when combined with stainless steel windows.

Flush type doors are available in standard RAL 9016 white and RAL 7016 grey, or any RAL colour.

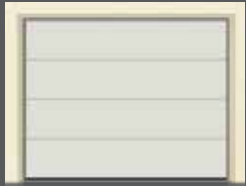

Around 200 RAL colours available.

### Panel styles:



RAL 9016  
(woodgrain)



RAL 9016  
(stucco)





TL&R40 | Cassette



## TL&R40 | CASSETTE

The Panelled Cassette door has stylish Georgian type rectangular panels beautifully sculptured with crisp lines and details on the outer surface. The cassette door is mainly suited to the traditional or country style home. Where there is timber decoration to the house the panelled cassette door, coated with a natural looking golden oak finish, will look perfect.

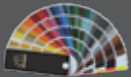

Around 200 RAL colours to choose from.

### Panel style:



RAL 9016  
(woodgrain)

### Wood image:



Golden Oak  
(woodgrain)





TL&R40 | Slick

## TL&R40 | SLICK

The top of the range Slick style door offers a totally flat and smooth panel surface. Double outside steel thickness is used to give this door a really solid look and performance. This door fits aesthetically in any style of building. The smooth surface is great for combining with stainless steel windows or decals.

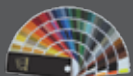

Around 200 RAL colours to choose from.



RAL PEARL colours.

### Panel style:



RAL 9016  
(smooth)



RAL 9006  
(smooth)



RAL 7016  
(smooth)





TL&R40 | Slick Plus

# TL&R40 | SLICK PLUS

Exclusively coated.

Smooth doors we call 'Slick Plus' are an original idea with an impressive Copper, Anthracite, Stainless Steel and Golden Oak finish.

Impressive looking Slick-Plus coating – Golden Oak, Stainless Steel, Copper, Anthracite Grey (similar RAL 7016), Anthracite Black (similar RAL 9005) and Anthracite Green (similar RAL 6009).

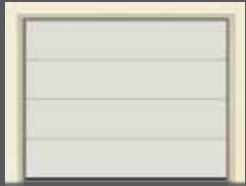

Around 200 RAL colours to choose from.

## Panel styles:



Golden Oak (smooth)



Stainless Steel (smooth)



Copper (smooth)



Anthracite Grey (smooth)



Anthracite Black (smooth)



Anthracite Green (smooth)



Golden Oak (smooth)



Stainless Steel (smooth)

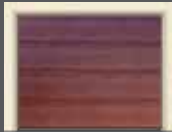

Copper (smooth)

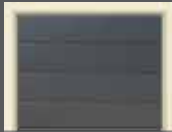

Anthracite Grey (smooth)

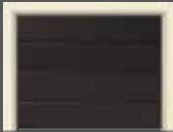

Anthracite Black (smooth)

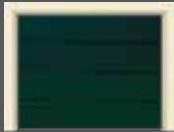

Anthracite Green (smooth)







TL&R40 | Microrib

## TL&R40 | MICRORIB

The Microrib. The strength of this modern style door lies in its exceptional smooth surface, slightly waving every 5 mm. These unique panels can be combined with stainless steel windows for a creative and practical appearance.

Microrib doors come in standard RAL 9016 white or finished in other RAL colours.

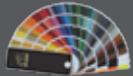
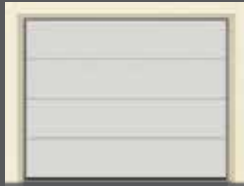

Around 200 RAL colours to choose from.

Panel style:



RAL 9016 (smooth)





TL&R40 | Macrorib



## TL&R40 | MACRORIB

The surface of macrorib door is stucco embossed and formed in soft waves every 10 mm. An attractive modern style door, suitable for both residential and commercial properties.

The Macrorib door comes in standard RAL 9007 or in any other RAL colours.



Around 200 RAL colours to choose from.

**Panel style:**



RAL 9007  
(stucco)





TL&R40 | Toprib

## TL&R40 | TOPRIB

Finally, the latest product from Ryterna. We call it the TOPRIB. The double groove design is one of the most discernible styles in the market. The extra thickness provides a high quality, smooth panel surface. Three double lines dividing panels make this door stand out from similar products.

A beautiful, contemporary door.



Around 200 RAL colours to choose from.



RAL PEARL colours.

**Panel style:**



RAL 9016  
(smooth)





TL&R40 | Retro

## TL&R40 | RETRO

The "old style" door made to fit the old style building.

Ribbed sections decorated with strips in woodgrain. Aluminum glazed panels with decorative grids between glasses and the same woodgrain planks covering aluminum. Fitted with old style metal hinges and handles.

Custom design available on request.







Side Hinged Garage Doors

## SIDE HINGED GARAGE DOORS

Insulated, robust, compatible with most garage door operators.

All designs, colours and panel models are available. You can choose options like windows, glazed panels, stainless steel appliques, wicket door or even pet-flap. Door leaves can be divided 50/50 or 70/30, handle can be on left or right side leaf. Handle standard colours: black, white, aluminium. As additional option door colour.

Tailor made max width 3 metres and max height 2.5 metre.



Door frame can be ordered with or without edge profiles.



Without edge profiles



With edge profiles



Easy fitting to side walls.



Hinges with springs

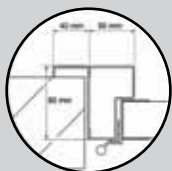

Frame dimensions.



Handle standard colours: silver, black, white. Other colours upon request.



## SIDE DOORS

Ryterna manufactures tailor made side doors to match the garage door you choose. Ryterna side doors are made of PU, insulated 40 mm panels, surrounded with aluminium profiles and 'all-round' rubber seals. Side door windows are aligned with sectional door panels or windows.

Double leaf entry doors available on request.

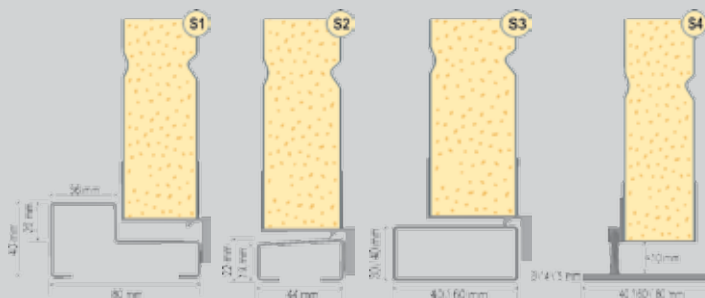





## PASS DOORS

When additional entry is required and there is no space for a side door, the wicket door fitted into the garage door could be an option. Wicket doors are supplied as standard with a door closer, lock and handle. You can choose the standard pass door or a new version with a low step, which is more convenient to get your bicycle or wheelchair through.

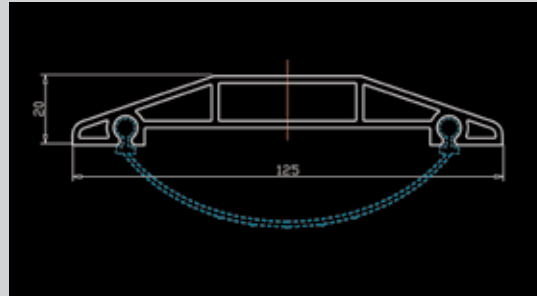



Decor Appliques





## DECOR APPLIQUES

Whilst a wide range of decors are offered by Ryterna, we welcome your personal artistic design to make your garage door an object of your own creativity. Forward your design and we will apply them to the garage door when possible. You can create the design to match your standard entrance door or similar. All we require are the measurements of the door you wish to match the design to and a picture of the existing door to copy the design.

Appliques are made in stainless steel and RAL coloured plate.

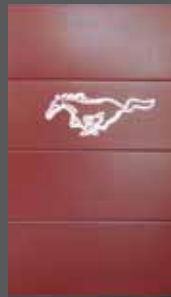



## STAINLESS STEEL WINDOWS

Using windows from our stainless design range will give your garage door a contemporary and unique appearance. Use our recommended designs or create your own.

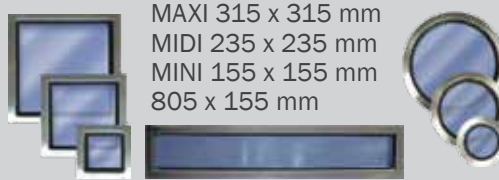

MAXI 315 x 315 mm  
 MIDI 235 x 235 mm  
 MINI 155 x 155 mm  
 805 x 155 mm

MAXI Ø 315 mm  
 MIDI Ø 235 mm  
 MINI Ø 155 mm

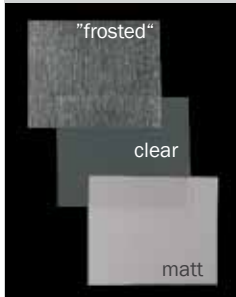

Acrylic double glazed windows come in a clear, matt or "frosted" finish.

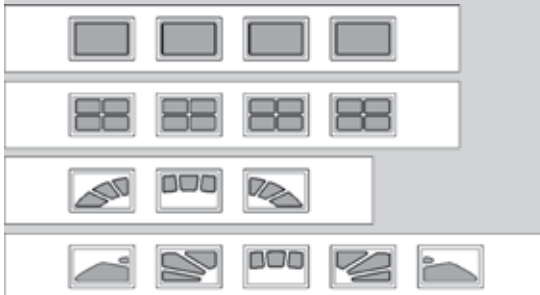

## ACRYLIC DOUBLE GLAZED WINDOWS

A range of windows and decorative inserts are offered to add distinction to any home. Acrylic window frames and inserts can be coloured to match your door or existing colours on your house.



## FULL VISION PANELS



Full vision panels can be provided in an anodized aluminium frame, with matching colours or in RAL golden oak effect to match existing windows and doors.



## HARDWARE TYPE R40

R40 sectional garage doors have been designed to be a consumer and installer friendly door – with its minimised headroom and side-room it is ideal for new houses as well as for replacing old garage doors. The made to measure and factory pre-assembled R40 door is very easy and fast to install.

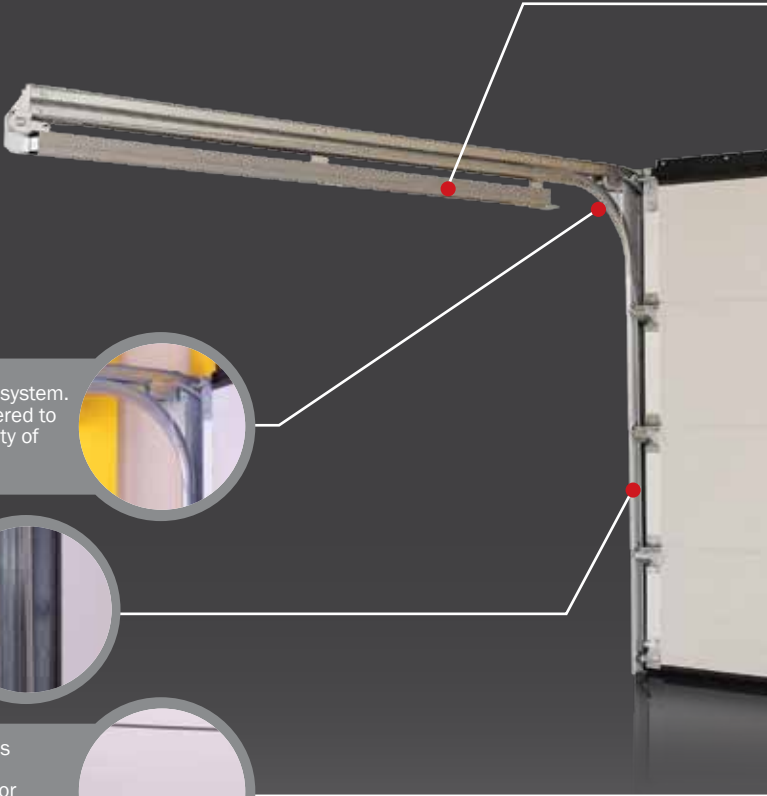

A safe and reliable track system. All Cable pulleys are covered to protect from the possibility of injury.

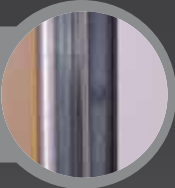

Rubber weather seals will ensure the door is properly closed from the bottom to the top. They also help to protect fingers.



The bottom seal works as a minor shock-absorber and eliminates minor floor irregularities, tightly closing the garage door.



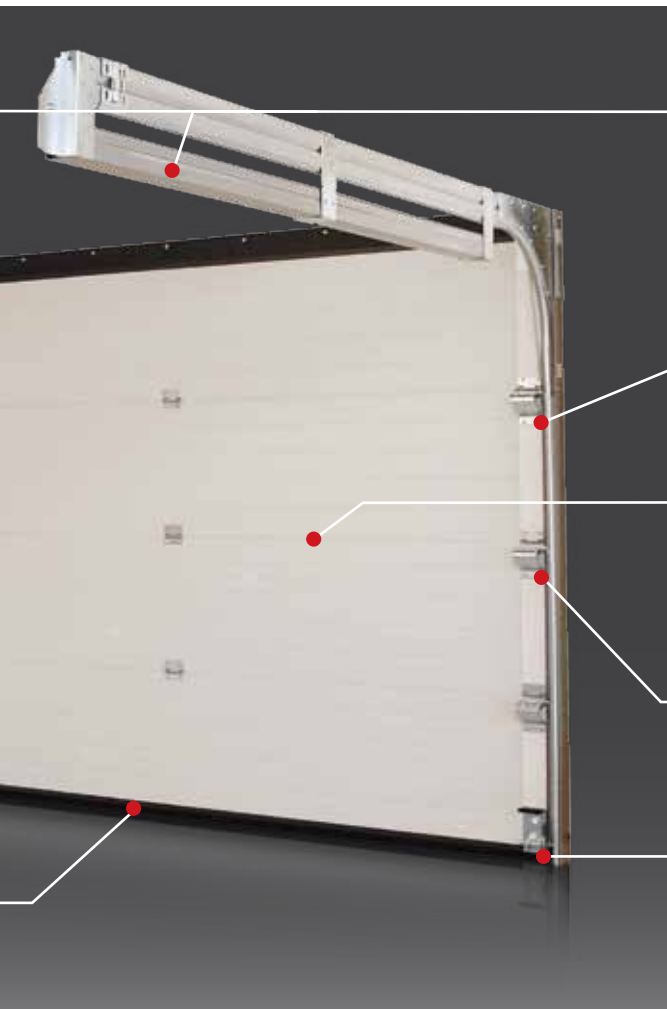

Tension springs assembly. Side mounted or under-track mounted springs are factory pre-installed and covered to grant an easy installation and safe operation. The four spring system protects the door even in the case of one spring failure.



Ball bearing rollers. Nylon coated rollers guarantee longer service and quiet operation.



Finger protection. Anti-pinching panels prevent the possibility of injury while operating the door.

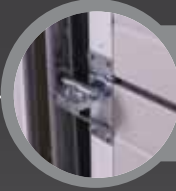

Side hinges with an adjustable roller carrier ensure the most efficient performance and keep it from derailing.



A convenient internal handle is located at the bottom corner and is very useful in case of power failure.

## HARDWARE TYPE R40

### Longer durability

R40 track system comes fully preassembled with tension springs, cables and accessories. The door with R40 type hardware is easily installed. Maximum R40 door measurements 3000 x 2500 mm.

### Technical specifications in accordance to EN 13241-1

### Safety features in accordance with EN 13241

- Tension spring
- Ball bearing rollers
- Safe track system
- Reinforced frame with side finger protection.
- Doors are tested to meet CE norm 89/107/EC
- Anti-pinching panels from the inside and outside.
- Insulation infill – CFC free PU foam.

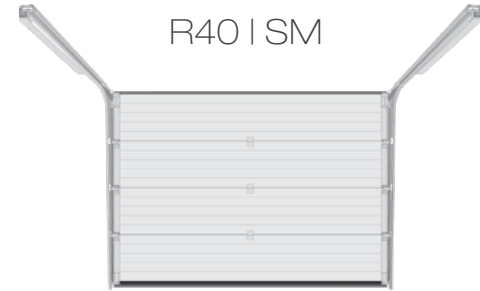
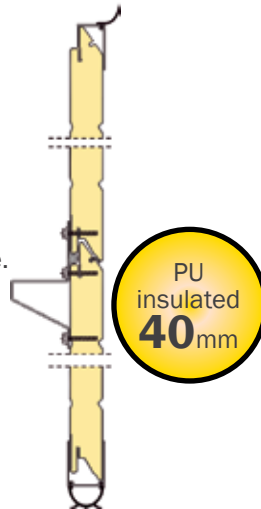

R40 | SM



R40 | UM



R40 | TM



# R40 | SM

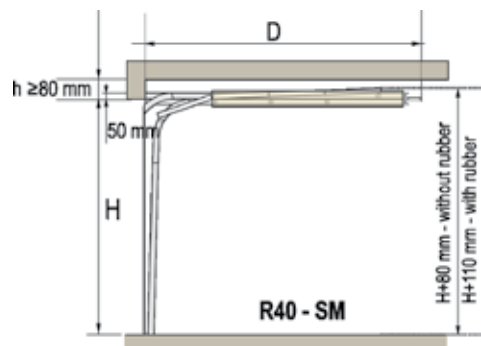

# R40 | UM

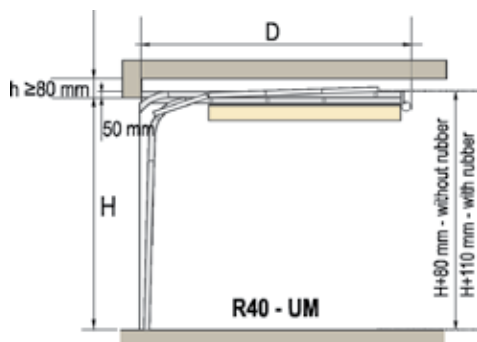

# R40 | TM

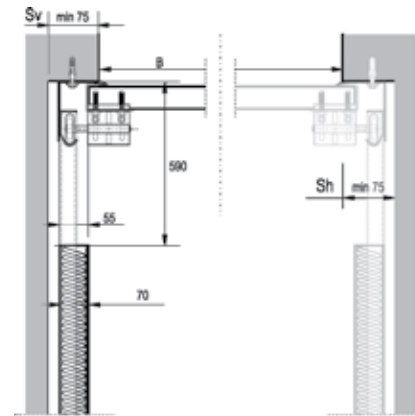
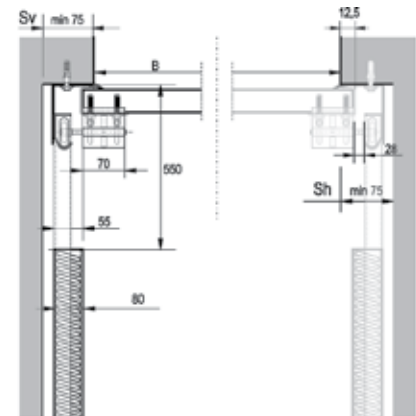
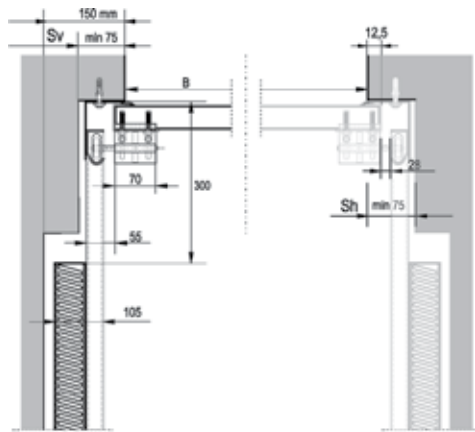
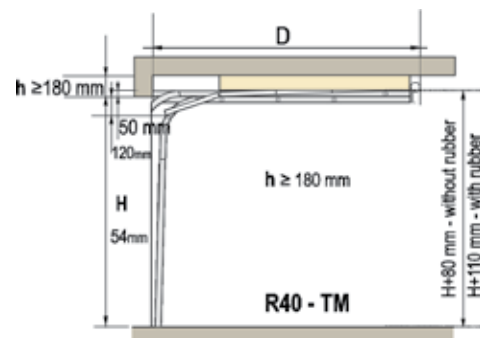

## HARDWARE TYPE TL

Components of our sectional garage doors have been developed and tested under the most demanding industrial conditions. Over decades of operations we have perfected every detail of our doors. We call it Intelligent Quality Control and it is a continuous process.

Safe and reliable track system. Industrial grade track is designed for reliable and secure operation.



Rubber weather seals at the sides will ensure the door is properly closed from the bottom to the top. They also serve as finger protection.

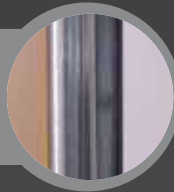

The bottom seal works as a minor shock-absorber and eliminates minor floor irregularities, tightly closing the garage door.



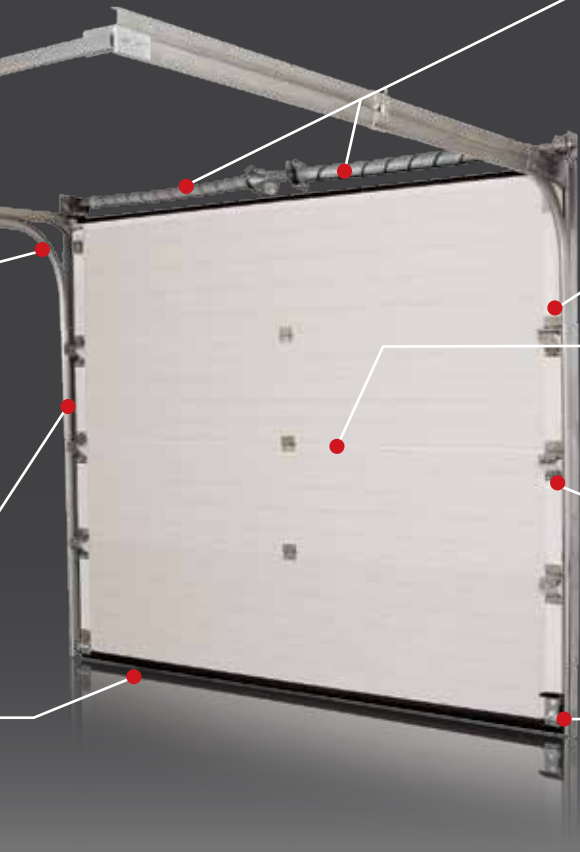

Torsion springs. Every garage door comes with a spring break protection mechanism for each spring in the system.



Ball bearing rollers. Nylon coated rollers guarantee longer service and quiet operation.

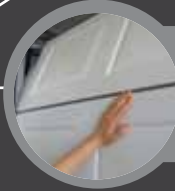

Finger protection. Anti-pinching panels keep fingers safe.

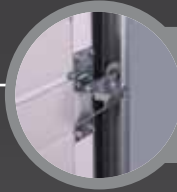

Side hinges with an adjustable roller carrier ensure most efficient roller performance and keep them from derailing.



A convenient handle is fitted at the bottom corner and is very useful in case of power failure.

## HARDWARE TYPE TL

### Longer durability

TL track system with torsion springs provides perfect counterbalance for a sectional door of any size or width. For challenging installation conditions we have developed LHR-FM and LHR-RM hardware types.

### Technical specifications in accordance with EN 13241-1

### Safety features in accordance with EN 13241

- Industrial grade torsion springs
- Ball bearing rollers
- Safe track system
- Reinforced frame with side finger protection
- Doors are tested to meet CE norm 89/107/EC
- Anti-pinching panels from the inside and outside.
- Insulation infill – CFC free PU foam.

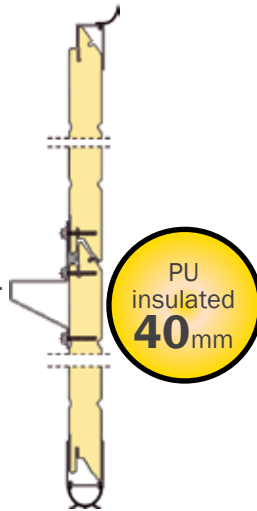

TL | LHR-FM with torsion springs

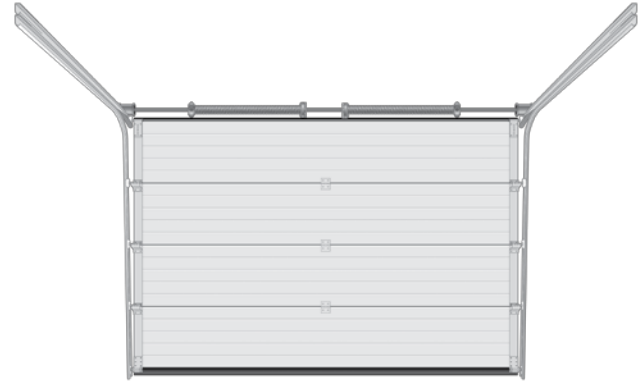

TL | LHR-RM with torsion springs

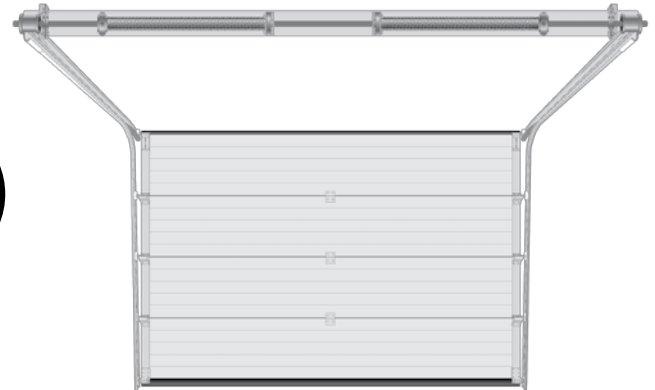

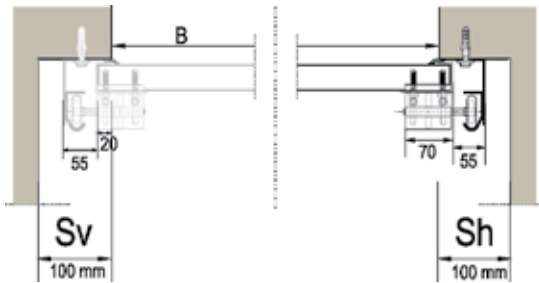

LHR FM low headroom lift double tracks, front mounted springs

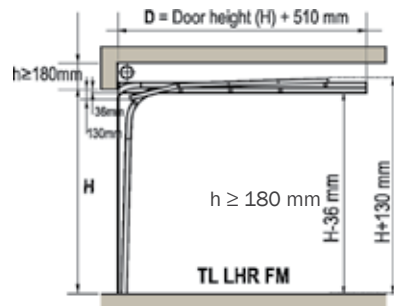

LHR RM low headroom lift double tracks, rear mounted springs

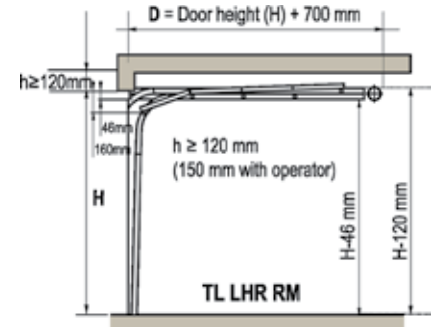

STD

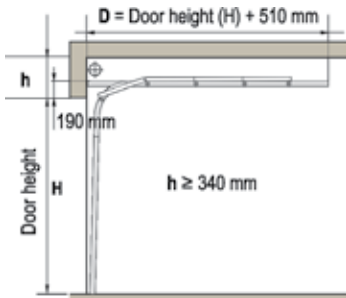

HL

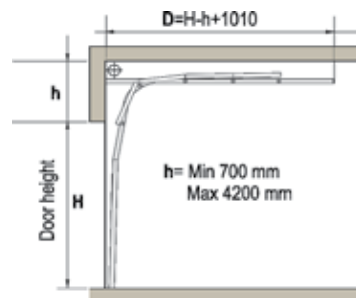

VL

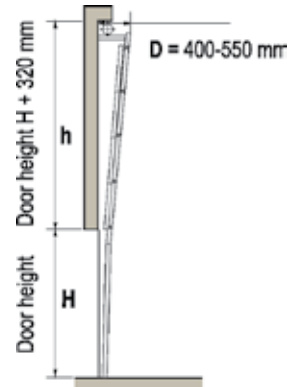

ROOF PICH

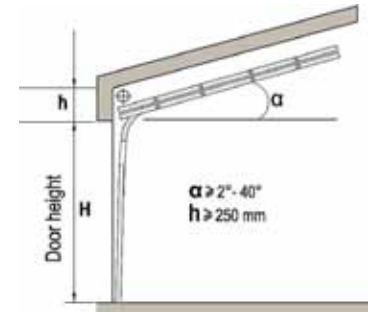



ALU frame (front installation)  
 Lintel + post.  
 Lintel 120 mm (suitable for  
 LHR RM and R40).  
 Lintel 180 mm (suitable for  
 LHR FM).  
 Posts 100 mm.

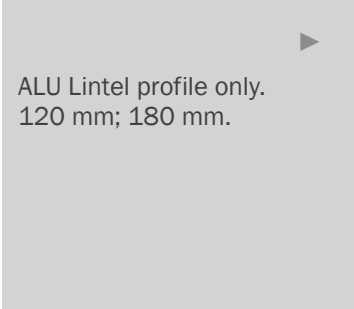
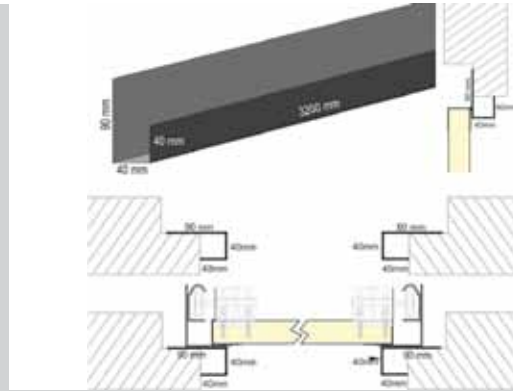

ALU Lintel profile only.  
 120 mm; 180 mm.



Reinforced lintel profile for fitting to the  
 ceiling. 40 x 40 x 90 x 3200 mm

Lintel profile with weatherseal 120 x 40 mm.  
 Standard black, also available in matching  
 door colour and structure.



Decorative angle  
 100 x 40 mm. Available in  
 woodgrain golden oak and  
 woodgrain white.



Accessories





White door leaf parts (hinges, top and bottom brackets) and even all track system coated in white are available as an option.



UNIVERSAL LOCK



DOOR LOCK



UNIVERSAL HANDLE



DOOR HANDLE



Most of our doors are electrically operated, but for those that will be used manually Ryterna offers lock and handle kits.



The Side Sliding Sectional Door

# THE SIDE SLIDING SECTIONAL DOOR

- The door is designed for an elegant look, convenient use and long life.
- Variety of panel designs – smooth, ribbed or embossed.
- Door can be partially opened – for pass door use, or just a half door opening. Convenient and thermally efficient.
- Corrosion-resistant and low maintenance aluminium hardware, top quality carriages and no-spring system provide quiet and trouble free operation.
- 40 mm PU panels and brush seals along the perimeter provide high thermal insulation.
- Low ground rail with no requirement for built in floor channel.

## Types of door sections:



## Standard colour:



Other painted colours similar to RAL palette.

## Panel styles:



## HARDWARETYPE

### The Side Sliding Sectional Door

Optional electric operator for your additional convenience.



Optional special lock for a manually operated sliding door.



Brush seals along all perimeters.

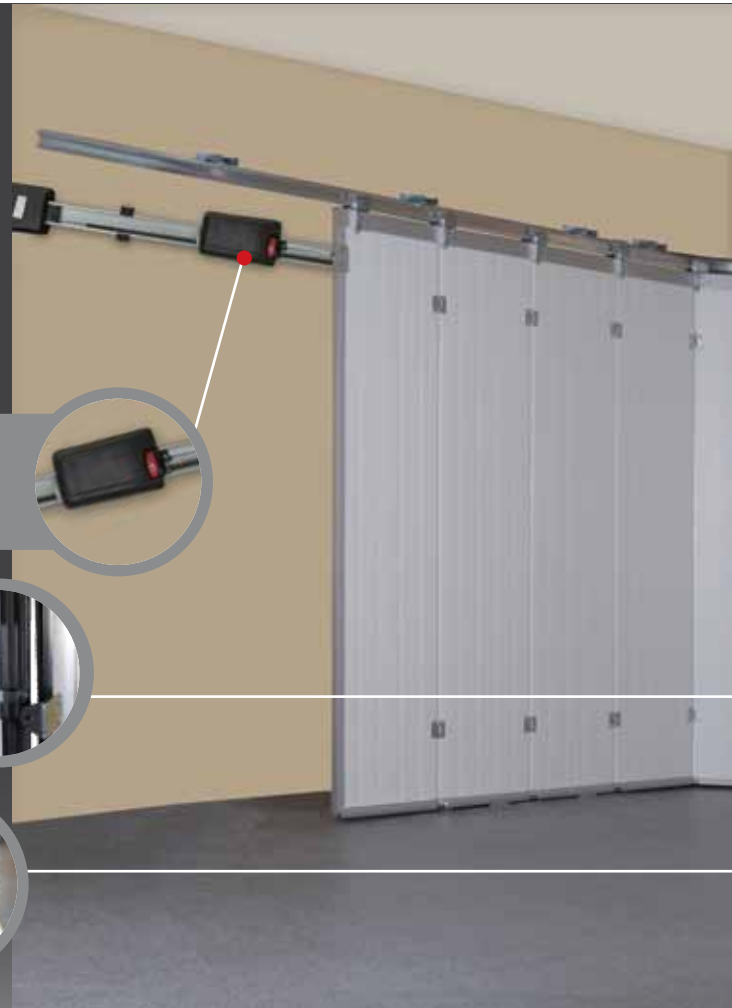
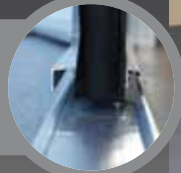

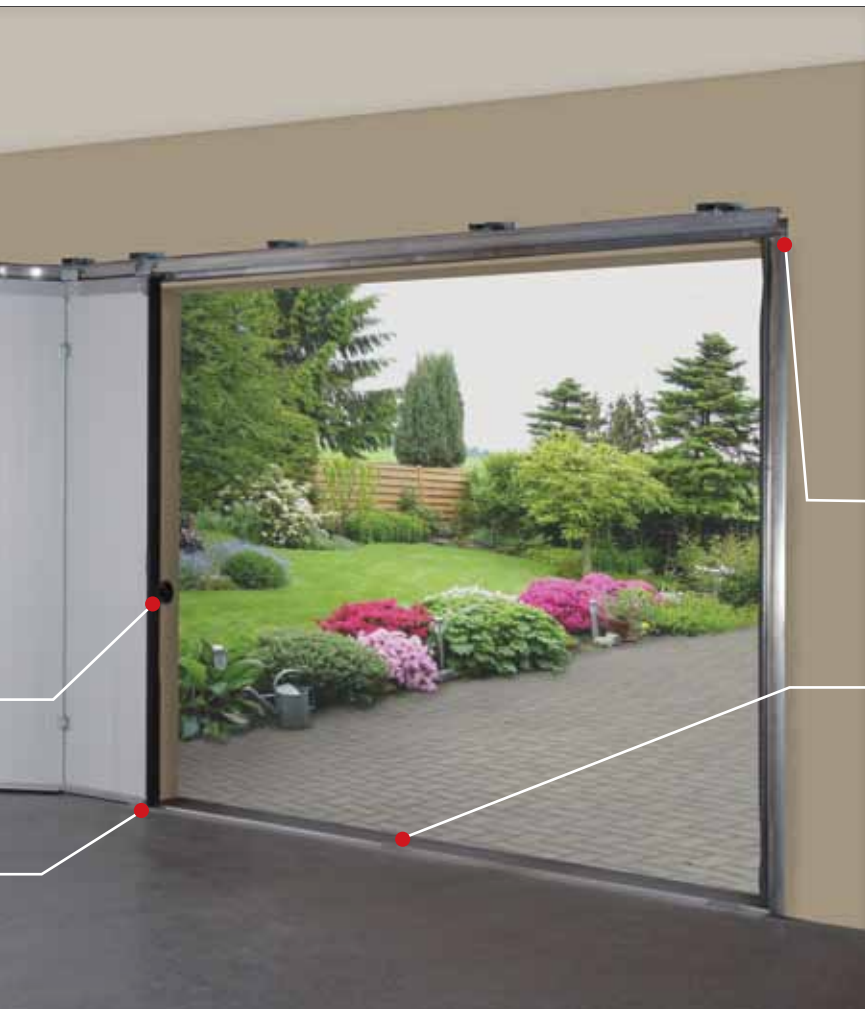

Ball bearing rollers, heavy duty carriages and solid rails designed for doors up to even 30 square metres.

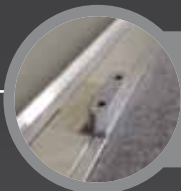

Low ground rail can be fixed on the existing floor – easy to fit and no maintenance required.



[www.ryterna.eu](http://www.ryterna.eu)

DEALER: